

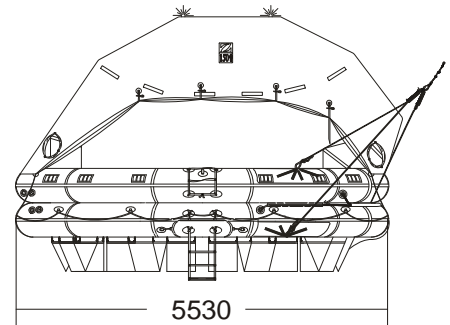

## MARINE EVACUATION SYSTEM (MES) 150 MAN THROW OVER BOARD SELF RIGHTING LIFERAFT ASSOCIATED WITH SMALL INFLATABLE SLIDE (SIS)

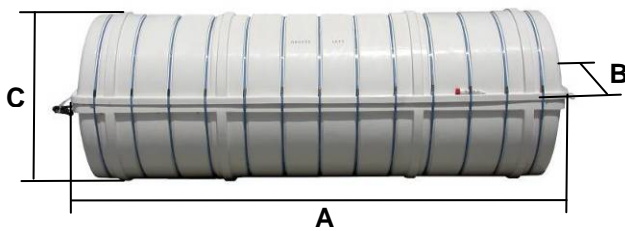
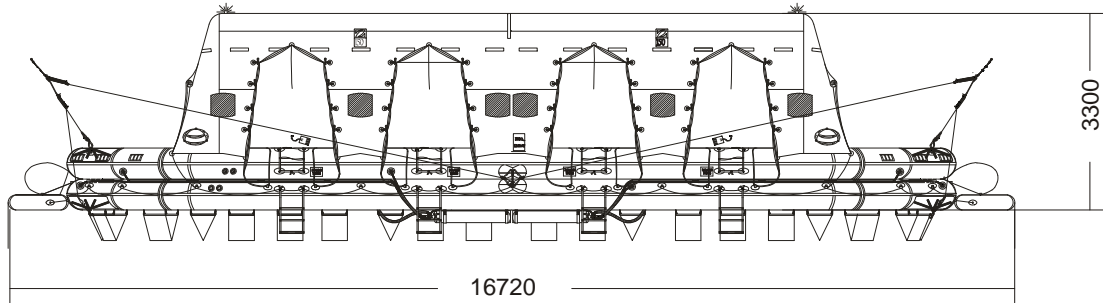
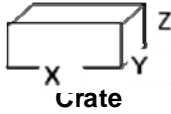

### TECHNICAL INFORMATION (SIS information on pages 2 & 3)

150 MAN MES SIS	A PACK			B PACK		
Container	N24			N23		
Dimensions	A: 3340 mm A: 10' 11,5"	B: 1150 mm B: 3' 9,28"	C: 1135 mm C: 3' 8,69"	A: 3340 mm A: 10' 11,5"	B: 1050 mm B: 3' 5,34"	C: 1035 mm C: 3' 4,75"
Liferaft Net Weight	1300 kg / 2866 pounds			880 kg / 1941 pounds		
Max. height stowage	25 m / 83'			25 m / 83'		
Firing line length	35 m / 115'					
Inflation Cylinder	6 x 35 liter					
 Crate	X: 3490 mm X: 11' 5,41"	Y: 1290 mm Y: 4' 2,79"	Z: 1280 mm Z: 4' 2,4"	X: 3490 mm X: 11' 5,41"	Y: 1190 mm Y: 3' 10,86"	Z: 1180 mm Z: 3' 10,46"
	1400 kg / 3087 pounds			970 kg / 2139 pounds		
	5,763 m3 / 203,49 cubic foot			4,901 m3 / 173,05 cubic foot		
Towing force	2 knots			3 knots		
Without sea anchor	240 daN			470 daN		
With sea anchor	270 daN			510 daN		

## SIS (SMALL INFLATABLE SLIDE)

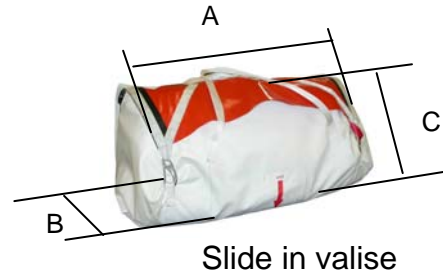

SIS	1,70 m	2,20 m
<b>Valise</b>		
Dimensions	A:670mm B:300mm C:260mm A:2' 2,38" B:1' 1,82" C:1' 0,24"	A:720mm B:425mm C:295mm A:2' 4,35" B:1' 4,74" C:1' 1,62"
Slide net weight	15 kg / 34 pounds	19 kg / 42 pounds
Max. evacuation height	1,70 m	2,20 m
Firing line length	1,50 m	1,50 m
Inflation cylinder	1 x 2,83 litres	1 x 4 litres

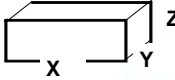
 <p>Crate</p>	X:830mm Y:540mm Z:330mm X:2' 8,68" Y:1' 9,26" Z:1' 1"	X:830mm Y:540mm Z:330mm X:2' 8,68" Y:1' 9,26" Z:1' 1"
	17,6 kg / 39 pounds	21,6 kg / 48 pounds
	0,148 m <sup>3</sup> / 5,23 cubic foot	0,148 m <sup>3</sup> / 5,23 cubic foot

SIS	2,70 m	3,20 m
<b>Valise</b>		
Dimensions	A:720mm B:450mm C:295mm A:2' 4,35" B:1' 5,72" C:1' 1,62"	A:800mm B:450mm C:295mm A:2' 7,5" B:1' 5,72" C:1' 1,62"
Slide net weight	27 kg / 60 pounds	28,5 kg / 63 pounds
Max. evacuation height	2,70 m	3,20 m
Firing line length	1,50 m	1,50 m
Inflation cylinder	1 x 6 litres	1 x 6,7 litres

 <p>Crate</p>	X:830mm Y:540mm Z:330mm X:2' 8,68" Y:1' 9,26" Z:1' 1"	X:830mm Y:540mm Z:330mm X:2' 8,68" Y:1' 9,26" Z:1' 1"
	29,6 kg / 66 pounds	31,1 kg / 69 pounds
	0,148 m <sup>3</sup> / 5,23 cubic foot	0,148 m <sup>3</sup> / 5,23 cubic foot

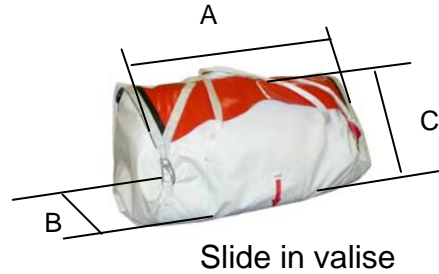

SIS	3,80 M		
	<b>Valise</b>		
	A: 820 mm	B: 450 mm	C: 350 mm
Dimensions	A: 2' 8,29"	B: 1' 5,72"	C: 1' 1,78"
Slide net weight	37 kg / 82 pounds		
Max. evacuation height	3,8 m / 13'		
Firing line length	1,5 m / 5'		
Inflation cylinder	1 x 10 liter		
<p><b>Crate</b></p>	X: 920 mm	Y: 560 mm	Z: 370 mm
	X: 3' 0,23"	Y: 1' 10,05"	Z: 1' 2,57"
	40 kg / 89 pounds		
	0,191 m <sup>3</sup> / 6,74 cubic foot		

**Approvals:** **EC (MED) - TC**

150 TO SR MES SIS cont rond Zodiac 04042011 KLT.doc Issue: 3 Date: 04/04/2011

Dimensions and weight +/- 5%      Zodiac reserves the right to change specification without notice.  
For installation, add minimum +10mm for clearance to dimensions of the container.