

ROUND CONTAINER 8 MAN THROW OVER BOARD LIFERAFT SOLAS A & B PACK

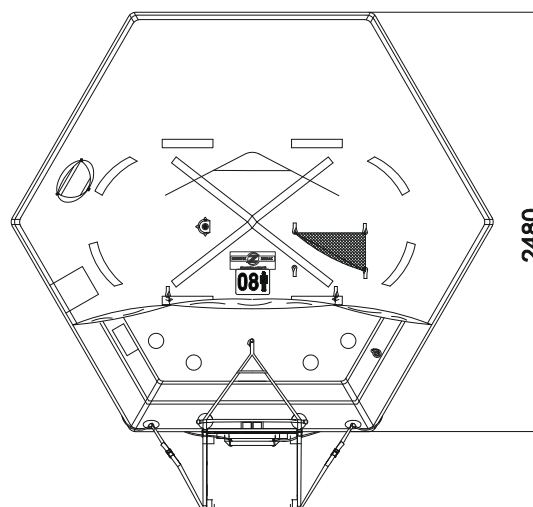
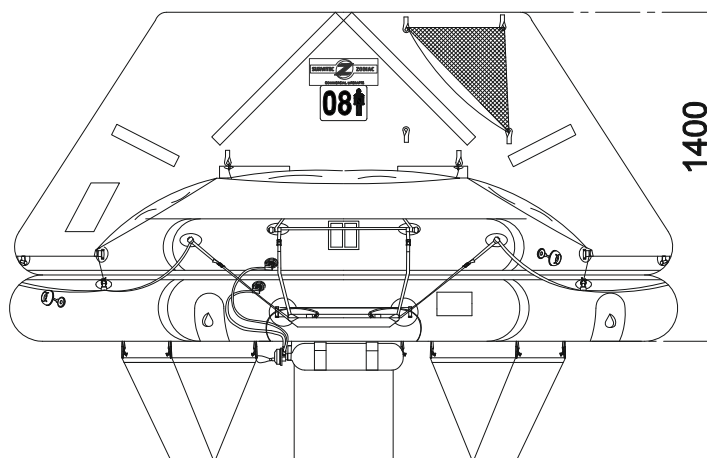
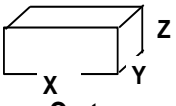

8 MAN	A PACK			B PACK		
Container	N12			N12		
Dimensions	X: 1160 mm X: 3' 9,67"	Y: 560 mm Y: 1' 10,05"	Z: 513 mm Z: 1' 8,2"	X: 1160 mm X: 3' 9,67"	Y: 560 mm Y: 1' 10,05"	Z: 513 mm Z: 1' 8,2"
Liferaft Net Weight	75 kg / 166 pounds			58 kg / 128 pounds		
Height stowage	25 m / 83'		36 m / 119'	25 m / 83'		36 m / 119'
Painter line length	35 m / 115'		50 m / 165'	35 m / 115'		50 m / 165'
Inflation Cylinder	1 x 6,7 liter					

 Crate	X: 1240 mm	Y: 620 mm	Z: 700 mm	X: 1240 mm	Y: 620 mm	Z: 700 mm
	X: 4' 0,82"	Y: 2' 0,41"	Z: 2' 3,56"	X: 4' 0,82"	Y: 2' 0,41"	Z: 2' 3,56"
	90 kg / 199 pounds			70 kg / 155 pounds		
	0,539 m3 / 19,01 cubic foot			0,539 m3 / 19,01 cubic foot		

Towing force	2 knots	3 knots
Without sea anchor	42 daN	65 daN
With sea anchor	87 daN	150 daN

Approvals:	EC (MED) – USCG – TC – RMRS – BV – CCS
-------------------	---

08 TO cont rond 13022017 KLT.doc	Issue: 8	Date: 13/02/2017
----------------------------------	----------	------------------

Dimensions and weight +/- 5%
 SURVITEC SAS reserves the right to change specification without notice.
 For installation, add minimum +10mm for clearance to dimensions of the container.